

91-1068 REV 01

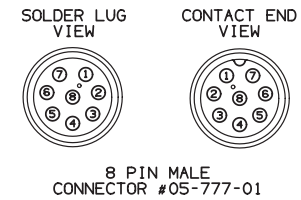
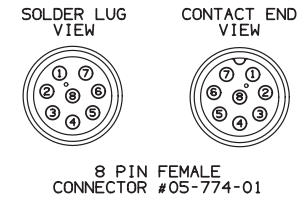
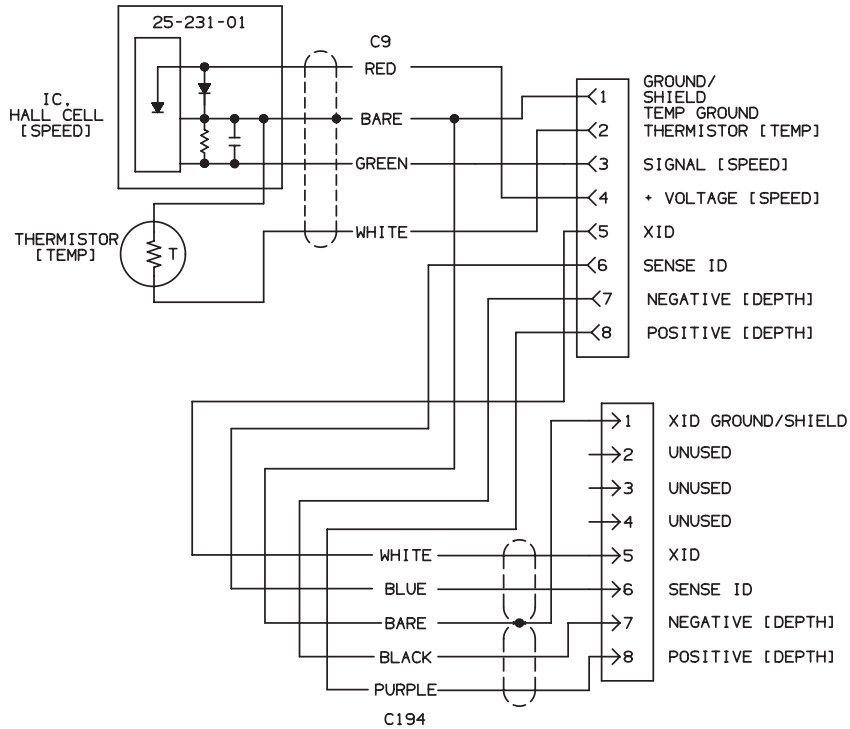

NOTE:

1. C9 BROWN IS CUT OFF ON BOTH ENDS.